

## Operation and Maintenance Documentation GUARD



---

**SONNIGER S.A.**

ul. Śląska 35/37, 81-310 Gdynia, Poland, infolinia 801 055 155, tel. + 48 58 785 34 80, [www.sonniger.com](http://www.sonniger.com)  
Sąd Rejonowy Gdańsk-Północ, VIII Wydział Gospodarczy Krajowego Rejestru Sądowego, KRS 0000966611, NIP 5862273514,  
Regon 22154369 kapitał zakładowy: 1.655.000 PLN

**1. PURPOSE OF THE DEVICE**

The air curtain is intended to be used in regions with a moderate and cold climate, in spaces where the temperature ranges from -10 to +40°C, in conditions free from external factors such as pollens and hydrometeor (horizontal precipitation). In winter, air curtains protect against heat loss in rooms by directing an airstream across the entrance and preventing cold air from entering the heated space. In summer, the curtains may be used as cooling devices preventing the entry of hot air and pollutants from outside.

The GUARD air curtains are designed to protect against heat losses in buildings of medium and high capacity and with a required mounting height of 4 m such as:

- ▮ supermarkets, large retail spaces,
- ▮ car showrooms and service stations,
- ▮ sports and show halls,
- ▮ exhibition surfaces

**2. BASIC TECHNICAL PARAMETERS**

TECHNICAL PARAMETERS	Curtain with water heater			Curtain with electric heater			Curtain without heater			
	GUARD 100W	GUARD 150W	GUARD 200W	GUARD 100E	GUARD 150E	GUARD 200E	GUARD 100C	GUARD 150C	GUARD 200C	
Length of unit	m	1	1.5	2	1	1.5	2	1	1.5	2
Max installation height	m	4			4			4		
Max air output	m <sup>3</sup> /h	1200/1550/2000	2200/3000/3600	2900/4000/4800	1200/1550/2000	2200/3000/3600	2900/4000/4800	1250/1600/2100	2250/3100/3700	3000/4200/5000
Heat output *	kW	10-16	20-29	25-40	4 - 7	6,5 - 11	8,5 - 14	-	-	-
Temperature increase ΔT **	ΔT	-	-	-	12	13	14	-	-	-
Max working pressure	MPa	1,6			-			-		
Diameter of connection nozzels	"	1/2'			-			-		
Motor power supply, consumption	V/Hz A	230/50 1,45A	230/50 1,45A	230/50 2,0A	230/50 1,45A	230/50 1,45A	230/50 2,0A	230/50 1,45A	230/50 1,45A	230/50 2,0A
Motor power supply, consumption ***	V/Hz A	220/60 1,8A	220/60 1,7A	220/60 2,2A	220/60 1,8A	220/60 1,7A	220/60 2,2A	220/60 1,8A	220/60 1,7A	220/60 2,2A
Motor power	kW	0,16	0,18	0,26	0,16	0,18	0,26	0,16	0,18	0,26
Electric heater power supply, consumption ****	V/Hz A	-	-	-	400/50 12,6A	400/50 19,1A	400/50 25,1A	-	-	-
Weight with water/without water	kg	18,0 / 16,5	22,6 / 20,5	31,0 / 28,0	17	21,5	29	15	18,5	25
Volume level I / II / III	dB (A)	44 / 49 / 59	45 / 49 / 61	46 / 49 / 61	44 / 49 / 59	45 / 49 / 61	46 / 49 / 61	45 / 50 / 60	46 / 50 / 61	47 / 50 / 61
Protection class IP		IP21			IP21			IP21		

\* heat output for water agent 90/70 and inlet air temperature 0°C

\*\* temperature increase for 18°C ambient air

\*\*\* version for KSA, Egypt

\*\*\*\* power consumption for ambient air temperature 18°C and cable length 10m

Energy consumption [A] goes higher in relation to decrease of air inlet temperature or extension of supply cables length

Noise level measured in distance of 3 m in open space building

**DIMENSIONS OF THE GUARD 100-150-200 W, E, C CURTAINS**

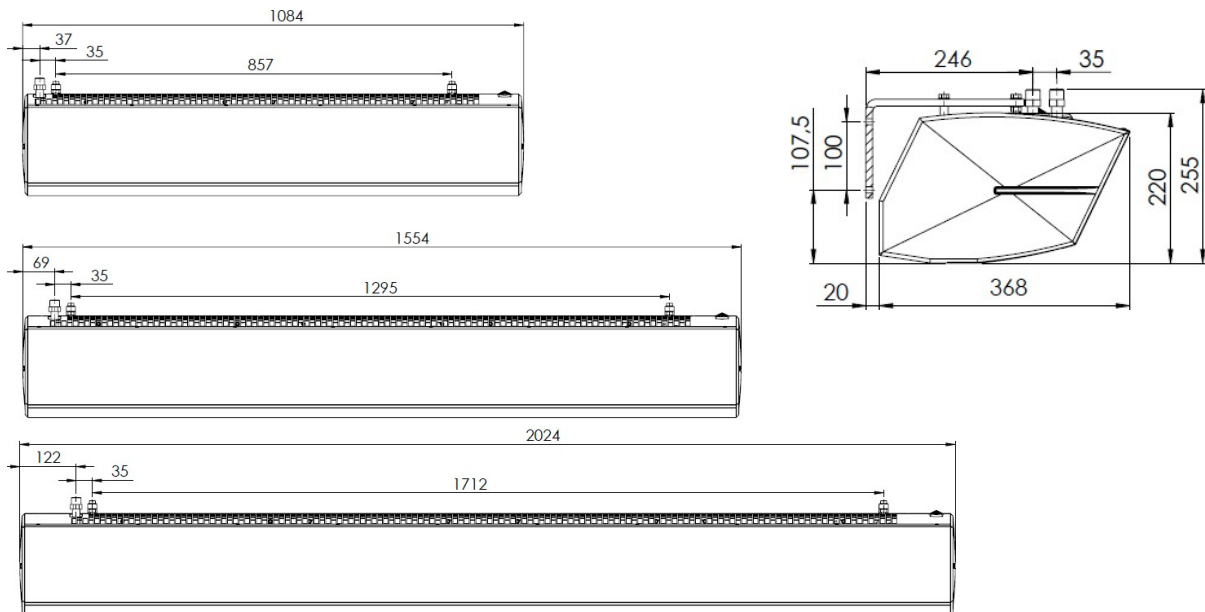

**GUARD 100-150-200 E Air curtains with electric heater**

GUARD E series (with electric heater) is based on a new type of PTC electric coils It is a modern and safe solution, additional advantages of PTC heaters

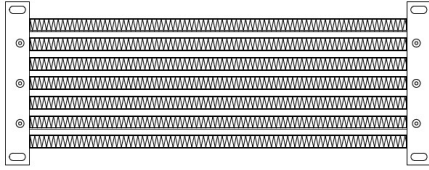

- ⚡ Lack of voltage on the surface of the electric coil
- ⚡ Significantly lower coil temperature in comparison to the old type of electric heaters (e.g. heating wires, spirals)
- ⚡ Large heat exchange surface (surface of contact of the heat exchanger with heated air)
- ⚡ Fully automatic heat control depending on airflow
- ⚡ Complete elimination of the risk of a system overheating due to self-regulating heating modules (heat capacity automatically reduces when airflow goes down)
- ⚡ Low energy consumption

**3. HEAT OUTPUT RANGES GUARD W**

GUARD 100W																										
inlet/outlet water temperature		50/30					60/40					70/50					80/60					90/70				
inlet air temperature		0	5	10	15	20	0	5	10	15	20	0	5	10	15	20	0	5	10	15	20	0	5	10	15	20
<b>III - max air flow - 2000 m3/h</b>																										
heat output	kW	6,6	5,6	4,6	3,6	2,6	9,0	7,9	6,9	5,8	4,8	11,3	10,3	9,2	8,1	7,1	13,7	12,6	11,5	10,5	9,4	16,0	14,9	13,9	12,8	11,7
outlet air temperature	°C	11,4	14,9	18,3	21,9	25,4	14,9	18,3	21,8	25,2	28,7	18,4	21,8	25,2	28,7	32,1	21,9	25,3	28,7	32,1	35,5	25,4	28,8	32,2	35,6	39,0
water flow	m³/h	0,2	0,2	0,2	0,1	0,1	0,4	0,3	0,3	0,2	0,2	0,5	0,4	0,4	0,3	0,3	0,6	0,5	0,5	0,4	0,4	0,7	0,6	0,6	0,5	0,5
pressure drop	kPa	1,0	1,0	0,6	0,6	0,3	2,0	2,0	1,0	1,0	1,0	4,0	3,0	2,0	2,0	1,0	5,0	5,0	4,0	3,0	2,0	7,0	6,0	5,0	5,0	4,0
<b>II - mid air flow - 1500 m3/h</b>																										
heat output	kW	5,9	5,0	4,2	3,3	2,4	7,9	7,0	6,1	5,3	4,4	10,0	9,1	8,2	7,2	6,3	12,0	11,1	10,2	9,2	8,3	14,0	13,1	12,2	11,2	10,3
outlet air temperature	°C	12,5	15,8	19,1	22,4	25,8	16,4	19,6	22,9	26,2	29,5	20,3	23,5	26,8	30,0	33,3	24,2	27,4	30,6	33,9	37,1	28,0	31,3	34,5	37,7	40,9
water flow	m³/h	0,2	0,2	0,1	0,1	0,1	0,3	0,3	0,2	0,2	0,2	0,4	0,4	0,3	0,3	0,2	0,5	0,4	0,4	0,4	0,3	0,6	0,5	0,5	0,5	0,4
pressure drop	kPa	1,0	1,0	0,5	0,5	0,2	2,0	2,0	1,0	1,0	0,0	3,0	2,0	2,0	1,0	1,0	4,0	3,0	3,0	2,0	2,0	6,0	5,0	4,0	4,0	3,0
<b>I - low air flow - 1200 m3/h</b>																										
heat output	kW	5,3	4,5	3,8	3,0	2,3	7,0	6,3	5,5	4,7	3,9	8,8	8,0	7,2	6,4	5,6	10,5	9,7	8,9	8,1	7,3	12,2	11,4	10,6	9,8	9,0
outlet air temperature	°C	13,7	16,8	19,9	23,0	26,2	18,0	21,1	24,1	27,2	30,3	22,3	25,3	28,4	31,5	34,5	26,6	29,6	32,7	35,7	38,8	30,9	33,9	36,9	40,0	43,0
water flow	m³/h	0,2	0,2	0,1	0,1	0,1	0,3	0,2	0,2	0,2	0,1	0,3	0,3	0,3	0,2	0,2	0,4	0,4	0,4	0,3	0,3	0,5	0,5	0,4	0,4	0,4
pressure drop	kPa	1,0	0,8	0,5	0,5	0,2	1,0	1,0	1,0	0,7	0,6	2,0	2,0	1,0	1,0	1,0	3,0	3,0	2,0	2,0	1,0	4,0	4,0	3,0	3,0	2,0

GUARD 150W																										
inlet/outlet water temperature		50/30					60/40					70/50					80/60					90/70				
inlet air temperature		0	5	10	15	20	0	5	10	15	20	0	5	10	15	20	0	5	10	15	20	0	5	10	15	20
<b>III - max air flow - 3600 m3/h</b>																										
heat output	kW	13,5	11,7	10,0	8,2	6,4	17,4	15,6	13,8	12,1	10,3	21,3	19,5	17,7	15,9	14,1	25,1	23,3	21,6	19,7	18,0	29,0	27,2	25,4	23,6	21,8
outlet air temperature	°C	11,9	15,4	18,9	22,5	26,0	15,1	18,6	22,1	25,7	29,2	18,3	21,8	25,3	28,9	32,4	21,5	25,0	28,6	32,0	35,6	24,7	28,2	31,7	35,2	38,7
water flow	m³/h	0,5	0,4	0,3	0,2	0,2	0,6	0,6	0,5	0,4	0,3	0,8	0,7	0,7	0,6	0,5	1,0	0,9	0,8	0,7	0,7	1,2	1,1	1,0	0,9	0,8
pressure drop	kPa	4,0	3,0	2,0	1,0	1,0	8,0	6,0	4,0	3,0	2,0	12,0	10,0	8,0	6,0	5,0	17,0	14,0	12,0	10,0	8,0	22,0	19,0	17,0	14,0	12,0
<b>II - mid air flow - 3000 m3/h</b>																										
heat output	kW	12,5	10,9	9,3	7,8	6,1	16,1	14,4	12,8	11,2	9,6	19,6	17,9	16,3	14,7	13,1	23,1	21,4	19,8	18,2	16,6	26,5	24,9	23,3	21,6	20,0
outlet air temperature	°C	12,7	16,1	19,5	22,9	26,3	16,2	19,6	23,0	26,4	29,8	19,7	23,1	26,5	29,9	33,2	23,2	26,5	29,9	33,3	36,7	26,6	30,0	33,4	36,7	40,1
water flow	m³/h	0,4	0,4	0,3	0,2	0,2	0,6	0,5	0,4	0,4	0,3	0,7	0,7	0,6	0,5	0,5	0,9	0,8	0,8	0,7	0,6	1,1	1,0	0,9	0,8	0,8
pressure drop	kPa	4,0	3,0	2,0	1,0	0,6	6,0	5,0	4,0	3,0	2,0	10,0	8,0	6,0	5,0	4,0	14,0	12,0	10,0	8,0	7,0	18,0	16,0	14,0	12,0	10,0
<b>I - low air flow - 2200 m3/h</b>																										
heat output	kW	11,0	9,7	8,4	7,0	5,7	14,0	12,6	11,3	9,9	8,6	16,9	15,5	14,2	12,9	11,5	19,8	18,4	17,1	15,7	14,4	22,7	21,3	20,0	18,6	17,3
outlet air temperature	°C	14,2	17,4	20,6	23,7	26,9	18,2	21,3	24,5	27,7	30,9	22,1	25,3	28,5	31,6	34,8	26,1	29,2	32,4	35,6	38,7	30,0	33,1	36,3	39,5	42,6
water flow	m³/h	0,4	0,3	0,2	0,2	0,1	0,5	0,4	0,4	0,3	0,3	0,6	0,6	0,5	0,4	0,4	0,8	0,7	0,6	0,6	0,5	0,9	0,8	0,8	0,7	0,6
pressure drop	kPa	3,0	2,0	1,0	1,0	0,6	5,0	4,0	3,0	2,0	1,0	7,0	6,0	5,0	4,0	3,0	10,0	8,0	7,0	6,0	5,0	13,0	11,0	10,0	8,0	7,0

GUARD 200W																										
inlet/outlet water temperature		50/30					60/40					70/50					80/60					90/70				
inlet air temperature		0	5	10	15	20	0	5	10	15	20	0	5	10	15	20	0	5	10	15	20	0	5	10	15	20
<b>III - max air flow - 4800 m3/h</b>																										
heat output	kW	19,5	17,2	14,8	12,4	9,9	24,7	22,3	19,9	17,5	15,1	29,8	27,4	25,0	22,6	20,2	34,9	32,5	30,1	27,7	25,3	40,0	37,6	35,2	32,8	30,4
outlet air temperature	°C	12,5	16,0	19,5	23,0	26,5	15,7	19,2	22,7	26,2	29,7	18,9	22,4	25,9	29,4	32,9	22,1	25,6	29,1	32,6	36,1	25,2	28,7	32,2	35,7	39,2
water flow	m³/h	0,7	0,6	0,5	0,4	0,2	0,9	0,8	0,7	0,6	0,5	1,1	1,0	0,9	0,8	0,7	1,4	1,2	1,1	1,0	0,9	1,6	1,5	1,4	1,3	1,2
pressure drop	kPa	9,0	6,0	4,0	3,0	1,0	15,0	12,0	9,0	7,0	5,0	22,0	19,0	15,0	12,0	9,0	32,0	27,0	23,0	19,0	15,0	42,0	37,0	32,0	27,0	23,0
<b>II - mid air flow - 4000 m3/h</b>																										
heat output	kW	18,2	16,0	13,8	11,7	9,4	22,8	20,7	18,5	16,3	14,1	27,5	25,3	23,1	20,9	18,8	32,1	29,9	27,7	25,5	23,4	36,6	34,5	32,3	30,1	27,9
outlet air temperature	°C	13,3	16,7	20,1	23,5	26,8	16,8	20,2	23,6	27,0	30,3	20,3	23,7	27,0	30,4	33,8	23,7	27,1	30,5	33,8	37,2	27,1	30,5	33,9	37,3	40,6
water flow	m³/h	0,6	0,5	0,4	0,3	0,2	0,8	0,7	0,6	0,5	0,4	1,0	0,9	0,8	0,7	0,6	1,2	1,1	1,0	0,9	0,8	1,4	1,3	1,2	1,1	1,0
pressure drop	kPa	7,0	5,0	4,0	2,0	1,0	12,0	10,0	7,0	5,0	4,0	19,0	16,0	13,0	10,0	8,0	26,0	22,0	19,0	16,0	13,0	35,0	30,0	26,0	22,0	19,0
<b>I - low air flow - 2900 m3/h</b>																										
heat output	kW	15,9	14,1	12,3	10,5	8,7	19,8	18,0	16,2	14,4	12,6	23,6	21,8	20,0	18,2	16,4	27,4	25,6	23,8	22,0	20,2	31,2	29,4	27,6	25,8	24,0
outlet air temperature	°C	15,0	18,1	21,3	24,4	27,5	18,9	22,1	25,2	28,4	31,5	22,9	26,0	29,2	32,3	35,5	26,8	29,9	33,1	36,2	39,4	30,7	33,8	37,0	40,1	43,3
water flow	m³/h	0,5	0,4	0,4	0,3	0,2	0,7	0,6	0,5	0,4	0,4	0,8	0,8	0,7	0,6	0,5	1,0	0,9	0,9	0,8	0,7	1,2	1,1	1,0	1,0	0,9
pressure drop	kPa	5,0	4,0	3,0	2,0	1,0	9,0	7,0	5,0	4,0	3,0	13,0	11,0	9,0	7,0	5,0	18,0	16,0	13,0	11,0	9,0	24,0	21,0	18,0	16,0	13,0

#### 4. GENERAL AND SAFETY PRINCIPLES

The GUARD air curtains are manufactured in compliance with the rules and standards concerning quality, ecology, utility, and work comfort. Before starting the device be sure to read the Manual carefully.

The GUARD air curtains are delivered ready-to-use in a cardboard package that is to protect from any mechanical damage. The package consists of the device, the Manual (Operation and Maintenance Documentation), and the Guarantee. If the optional automatic control is ordered, it shall be delivered in a separate package. Make sure all the aforementioned elements are in the package immediately after delivery. In the absence of any element, please fill in the suitable carrier document.

##### NOTICE!

- ⚡ Do not use the curtain in rooms containing any flammable and/or combustible substances, biological substances, or in environments with corrosive air components.
- ⚡ Do not use the curtain in rooms with relative humidity above 80%
- ⚡ Do not leave the curtain ON unattended for long periods
- ⚡ Do not use the curtain without proper grounding
- ⚡ Do not turn the curtain on without a protective cover in place
- ⚡ Before conducting any maintenance or cleaning work or during the break-in operation for an extended period, make sure you unplug the power cable
- ⚡ To connect the air curtain, use a supply cable with a fork that protects against unintended disconnecting from the power
- ⚡ When the air curtain is connected directly to the cable, please make sure there is a splitter protecting against any undesired disconnecting
- ⚡ Pay special attention while transporting the device not to damage the casing
- ⚡ When the device is being operated, ensure the safety rules following the labor standards relating to the operation of any electrical devices
- ⚡ Do not place any objects on the curtain or reduce the airflow to ensure fire safety and if sparks or a damaged supply cable are noticed, discontinue the operation immediately
- ⚡ The electricity network, to which the curtain is connected, should be protected against overloading and short circuit

##### CAUTION!

- ⚡ To avoid the serious danger of electric shock, installation must be performed by a qualified electrician
- ⚡ To avoid the danger of electric shock disconnect the power supply before conducting any repair or maintenance work
- ⚡ Any leakage repairs of the heating medium in the device, of which pipes are under pressure, are strictly prohibited
- ⚡ A cut-off/stop valve must be used to supply a heating medium
- ⚡ It is prohibited to connect the grounding-type plug to water pipes, gas tubes, lightning conductors, telephone or antenna network
- ⚡ Wait for at least 3 hours before connecting the device to the power supply if the temperature while transporting is below zero

##### NOTICE !

- ① Before mounting the device, read the manual carefully and adhere to the rules concerning the mounting procedures. Not applying to the rules may result in the inappropriate functioning of the device and the loss of the guarantee rights.
- ① Pay special attention when working with electrical elements of the device.

#### 5. INSTALLATION

When deciding on the air curtain position you should take into account such factors as:

- ⚡ Ease of access for servicing,
- ⚡ Access to water and electricity supplies

It is recommended to install the air curtain in position above the entrance opening, on the wall or under the ceiling, on support pins or horizontal mounting brackets. It is also possible to mount it vertically to a wall or other structure using vertical mounting brackets.

It's important to make sure that the unit is properly leveled. In case of positioning in a different way than horizontally or vertically, during installation, damage to the fan may occur and as a consequence malfunction of the unit.

Inlets and outlets cannot be blocked by any objects. When installing the curtains, keep in mind that you will have free access to the control panel. With larger door openings, it is possible to mount more curtains of the same type, one by one, to create an uninterrupted airflow. The curtain is permanently mounted in either a horizontal or vertical position (on the left/right side of the entrance).

Curtain connection should be done in a serviceable manner, manual shut-off valves should be installed on both nozzles to enable disconnection. In the case of a solenoid valve (option - automatics), it must be connected to the water outlet of the device, otherwise, it may be damaged. When tightening the pipeline to the exchanger, the heater connection must be protected against torque (which may cause leakage in the exchanger).

**Horizontal installation under the ceiling using mounting pins**

Installation under the ceiling is done by using 4 M8 pins. To hang the device on the pins, drill holes  $\varnothing$  8-9mm in the EPP housing directly in front of the existing holes in the steel inlet grille. The exact location is indicated by special tags on the EPP housing. The pins should be screwed into the nippers at a depth of 9 mm.

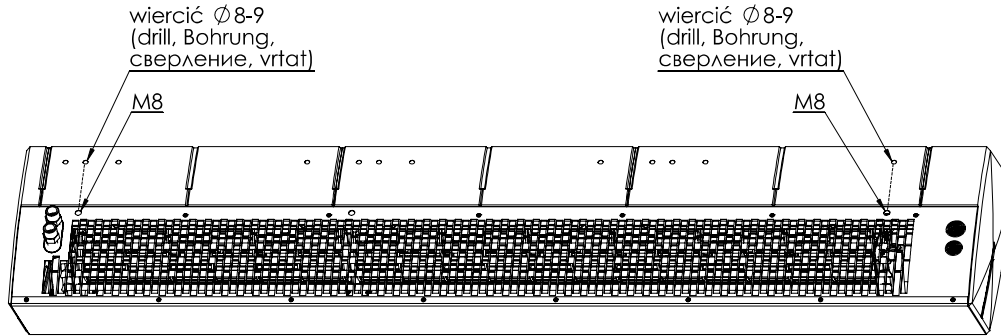

Drawing below shows the position of the mounting holes for the pins

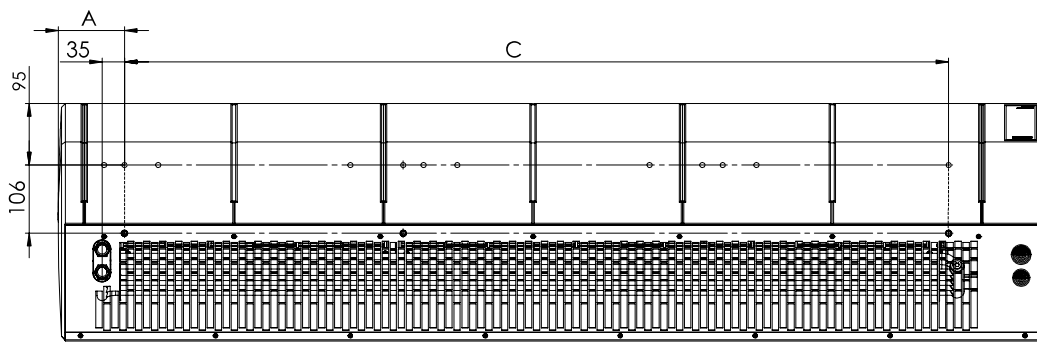

Curtain size	A(mm)	C(mm)	Nuber of pins M8
100	72	857	4
150	104	1295	4
200	157	1712	4

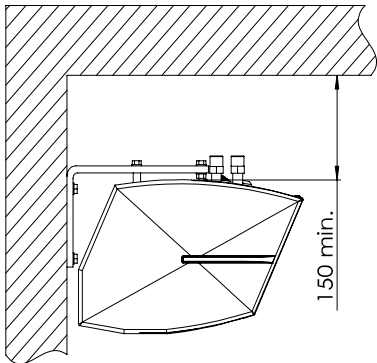

**Wall installation by means of a horizontal brackets**

The curtain can be mounted to the wall in a horizontal position using 2 mounting brackets to the horizontal system. In the brackets there are  $\varnothing$ 9mm holes for M8 screws. In the EPP housing, drill holes  $\varnothing$  12-13mm in front of existing holes in the steel intake grille. The exact location is indicated by the special tags on the EPP housing and the figure below. Then insert the spacer sleeves into the holes and fix the brackets. Screw the remaining screws into the nuts under the steel intake grille so that both grips are in one plane. Locknuts under the handles are used to secure the screws from unscrewing.

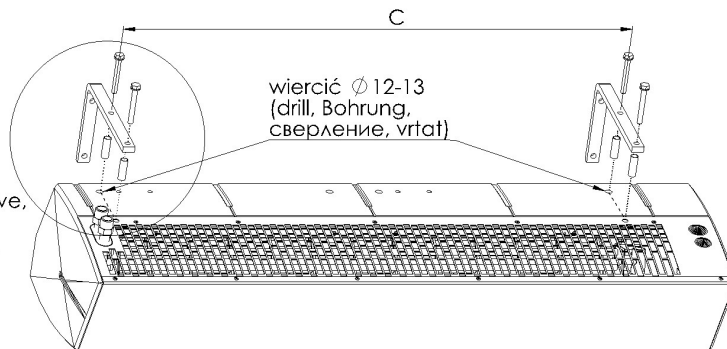
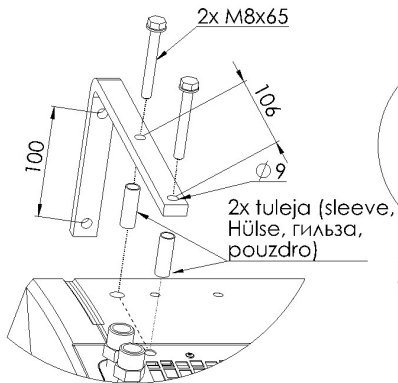

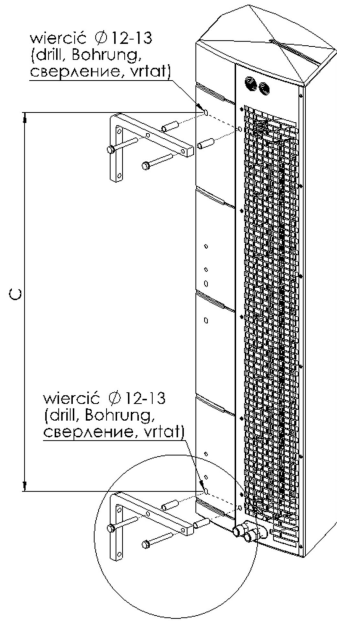

### Installation using brackets for vertical mounting

It is also possible to install the unit vertically with the engine downwards and upwards. Two vertical mounts are used for this purpose. In the brackets there are Ø9mm holes for M8 screws. In the EPP housing, drill holes Ø 12-13mm in front of existing holes in the steel intake grille. The exact location is indicated by special tags on the EPP housing and the figure below. Then insert the spacer sleeves into the holes and fix the brackets. Screw the remaining screws into the nuts under the steel intake grille so that both grips are in one plane. Locknuts under the handles are used to secure the screws from unscrewing.

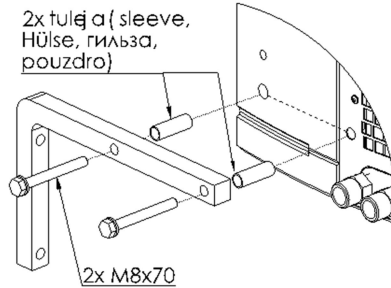

Curtain size	C(mm)	Number of brackets
100	857	2
150	1295	2
200	1712	2

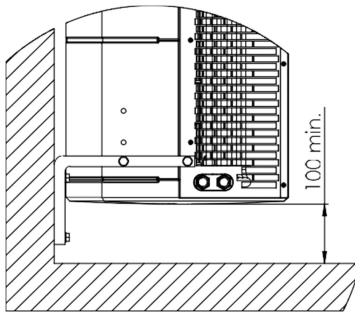

### Connection of heating medium

The connection of the heating medium to the heat curtain, using G 1/2" threaded connections should be made based on a design by an authorized designer. If the air curtain is connected to a district heating network without a mixing unit, a water filter is required. The direction of connection to the water heater does not affect air curtain works.

In the case of horizontal and vertical mounting with nozzles at the top, the exchanger is vented through the nozzles. If the device is mounted vertically with nozzles at the bottom to vent the exchanger, use a vent that is located on the exchanger collector on the engine side.

### ATTENTION !

- ❶ It is necessary to ensure that the unit is properly leveled. When it is mounted in a position other than vertical or horizontal there is a risk of fan damage and unit malfunction
- ❶ The minimum distance between device and floor cannot be less than 100 mm

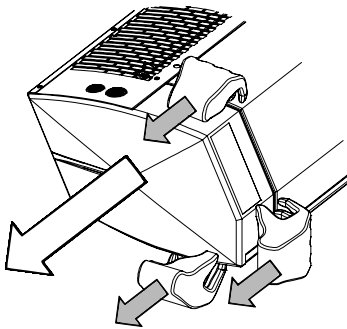

### Connecting the power supply and control system of the curtain

To connect the power supply, control and/or bleed the Exchange move out the right lid, which is fastened with the lock to the lower steel housing and the main housing EPP. The lid is disassembled in the direction shown by the arrows in the figure below. The lid should be grasped in the following places indicated in the drawing and should be gradually "released" from the locks for several millimeters. Cable entries for power and control cables are located on the inlet grille.

### ATTENTION !

- ❶ Ensure that no connection wire is clamped between the lid and the rest of the curtains before assembling the lid.

## 6. CONTROL PANEL

A set of automatic control may be used (powered 230V) that consists of the following:

- ☞ COMFORT NEW panel – including room thermostat and switch for regulation of 3 speeds of the fan.
- ☞ One COMFORT panel may regulate up to 2 pcs of GUARD
- ☞ 2-way water valve with actuator; valve should be installed on a return stub of the heater
- ☞ INTELLIGENT electronic control panel with an automatic speed controller, weekly program, and BMS communication.  
One INTELLIGENT panel may regulate up to 2 pcs of GUARD
- ☞ Splitter MULTI 6 - control up to 6 pcs of GUARD

The system is ready to start once the connections between the thermostat and the valve actuator are done, 230V power is supplied to the thermostat and the fan's motor is powered by the revs controller.



### COMFORT NEW panel description

**OFF-I-II-III** - switch and fan speed regulation

**HEAT** - the thermostat gives an operation signal to the actuator and fan, the fan turns off when the set temperature is reached, the valve closes the water supply

**FAN** - device fan operation according to the thermostat, valves or electric heaters do not work

**COOL** - the thermostat gives an operation signal to the actuator and fan, the device starts to work when the set temperature is reached

It is possible to use an additional change of the SR1 to SR1 CONST jumper position, in this case the fan can operate regardless of the thermostat. Thermostatic operation is only for valves. In this case:

**HEAT** - fan operation regardless of the thermostat, valves work up to the set temperature

**FAN** - device fan operation, regardless of the thermostat, valves do not work

**COOL** - fan operation regardless of the thermostat, valves work from the set temperature

## 7. GUARD DOOR SWITCH

The **GUARD (DC)** door switch is an additional element for switching the curtain on/off, depending on the opening of the door.

It is designed for indoor installation. It includes:

- ☞ Relay cabinet - reed relay switchboard
- ☞ Reed relay - Reinforcement for door-fitting, hermetic magnetic switch, consisting of a movable and fixed element

Scheme of the relay cabinet – reed relay interface

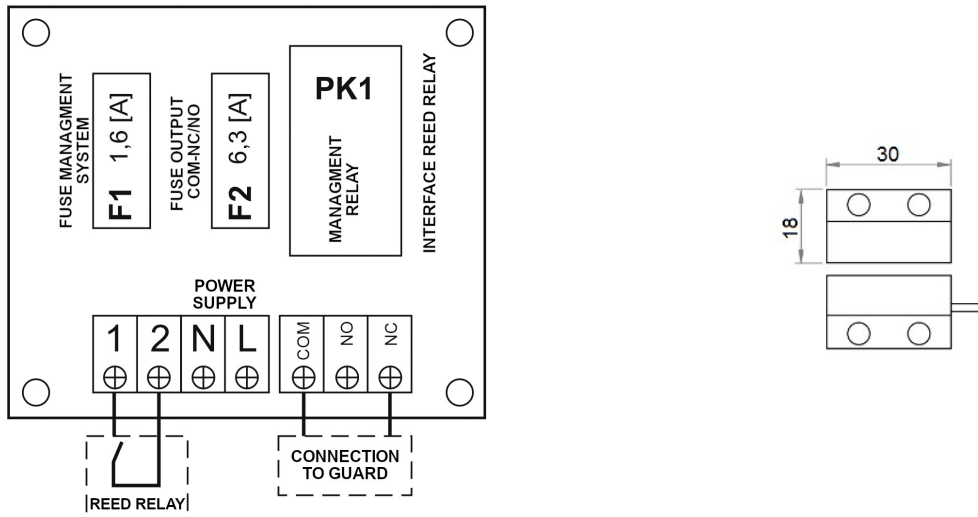

When installing the GUARD door switch, remove the factory-made jumper:

**NC-1** for curtain GUARD W (curtain with a water heater) / GUARD C (curtain without a water heater)

**NC-COM** for curtain GUARD E (curtain with an electric heater)

## 8. DIAGRAMS OF ELECTRICAL CONNECTIONS

The electrical network to which the curtain will be connected should protect against overheating and short-circuiting. It is necessary to protect the air curtain by grounding. Electrical installation and connection to the air curtain must be following applicable building codes and regulations, electrical connection should be carried out by a qualified person familiar with the above instruction. The fan motor has standard internal thermal protection to protect the motor from overheating. The set does not include: a power cord, or main switch

\*diameter and length of the cable should be following local regulations (some deviations are acceptable)

**8.1 Diagram of connecting one GUARD 100-150-200 W (water heater) and C (without heater) to the COMFORT panel**

*\*The unit set does not consist of: a master switch, a fuse, a feeding cable*

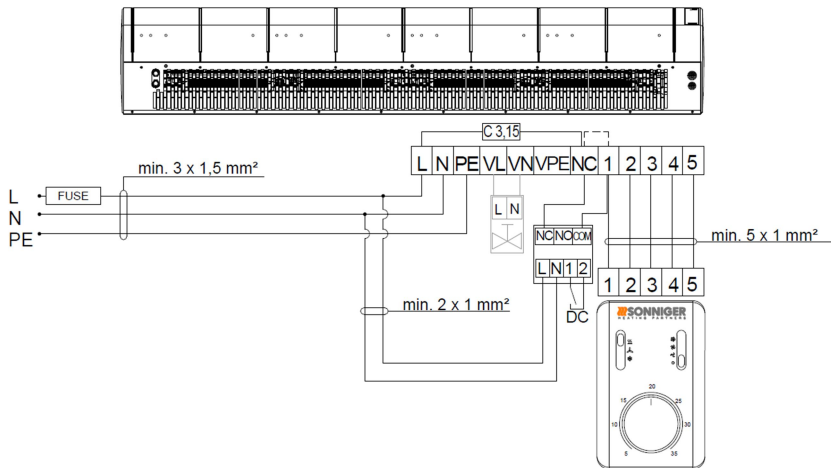

In case of working without DOOR SWITCH the bridge between terminal NC-COM need to be keep.

**8.2 Diagram of connecting two GUARD 100-150-200 W (water heater) and C (without heater) to one COMFORT panel**

*\*The unit set does not consist of: a master switch, a fuse, a feeding cable*

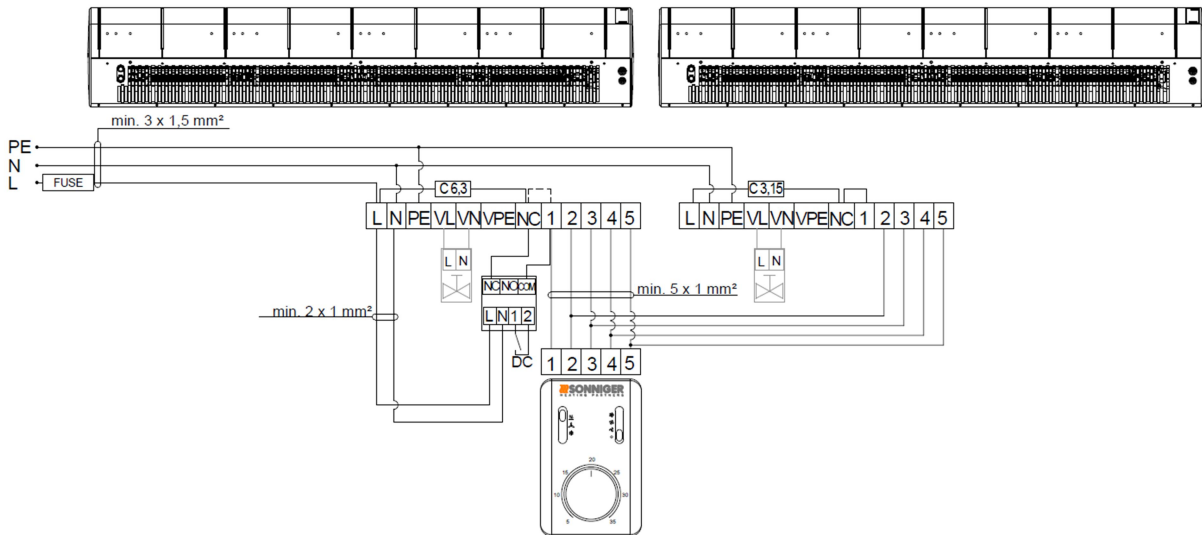

In case of working without DOOR SWITCH the bridge between terminal NC-COM need to be keep.

In the MASTER curtain between the L-NC terminals, replace the factory-made fuse (C 3.15) with C 6.3 (for work with DOOR SWITCH remove the bridge between terminal NC-1)

**8.3 Diagram of connection of one GUARD 100-150-200 E curtain (electric heater) to the COMFORT panel**

*\*The unit set does not consist of: a master switch, a fuse, a feeding cable*

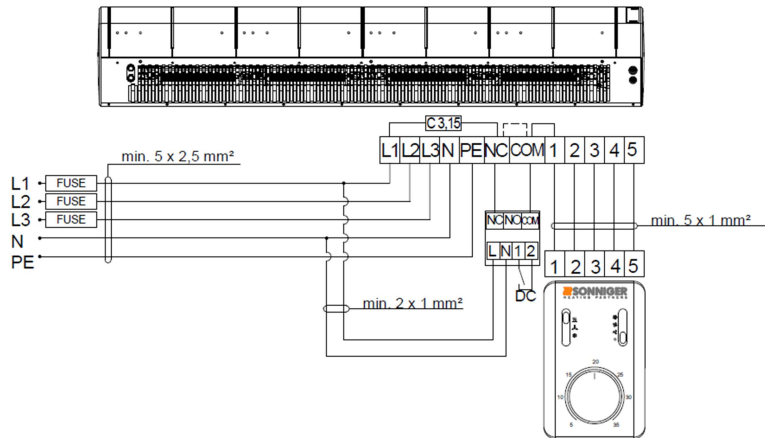

In case of working without DOOR SWITCH the bridge between terminal NC-COM need to be keep.

**8.4 Diagram of connection of two GUARD 100-150-200 E curtain (electric heater) to one COMFORT panel**

*\*The unit set does not consist of: a master switch, a fuse, a feeding cable*

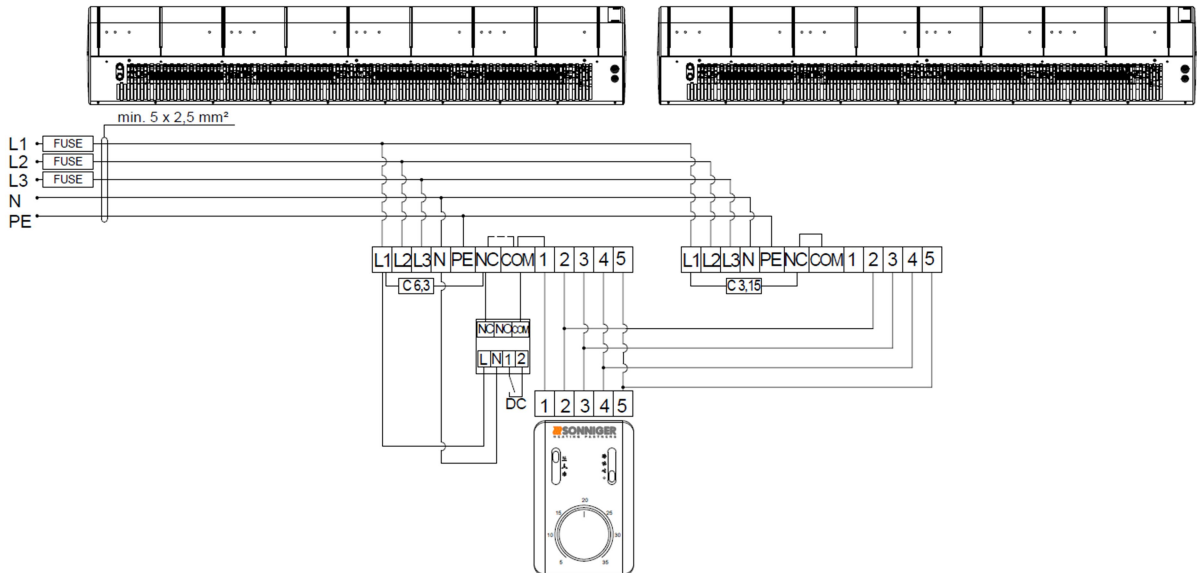

In case of working without DOOR SWITCH the bridge between terminal NC-COM need to be keep.

In the MASTER curtain between the L-NC terminals, replace the factory-made fuse (C 3.15) with C 6.3 (for work with DOOR SWITCH remove the bridge between terminal NC-COM)

**ATTENTION!**

- ① PTC heaters power supply 3x400V/50Hz or 3x400V/60Hz
- ① min. 5 x 2,5 mm for G100E; (B16)
- ① min. 5 x 4 mm for G150E; (B20)
- ① min. 5 x 6 mm for G200E; (B25)

**8.5 Connection diagram of GUARD 100-150-200 W and C with INTELLIGENT**

**8.5.1 With DOOR SWITCH**

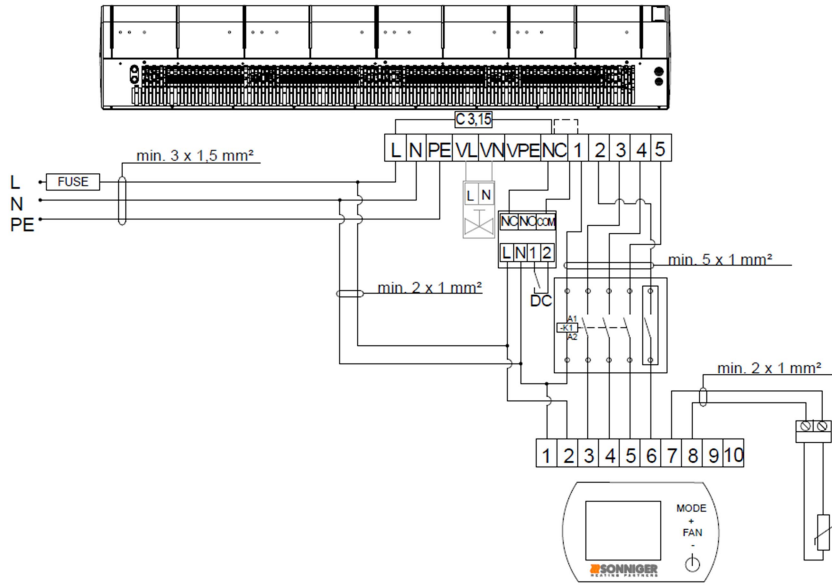

**8.5.2 Without DOOR SWITCH**

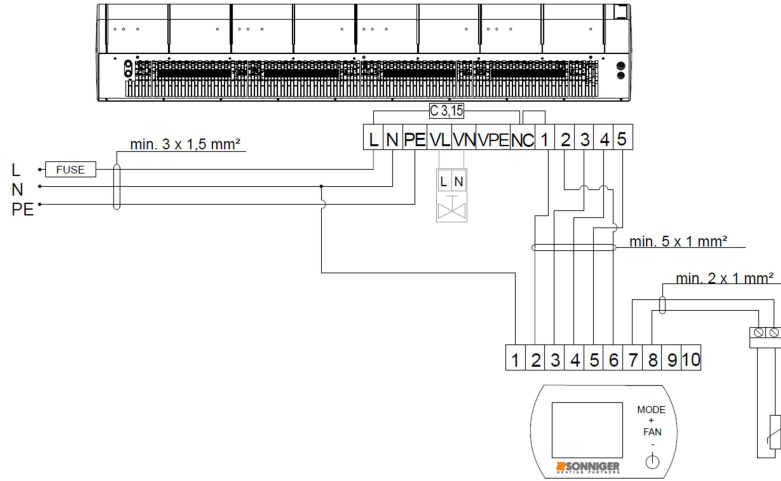

**8.6 Diagram of connecting two GUARD 100-150-200 W and C to the INTELLIGENT panel**

**8.6.1 With DOOR SWITCH**

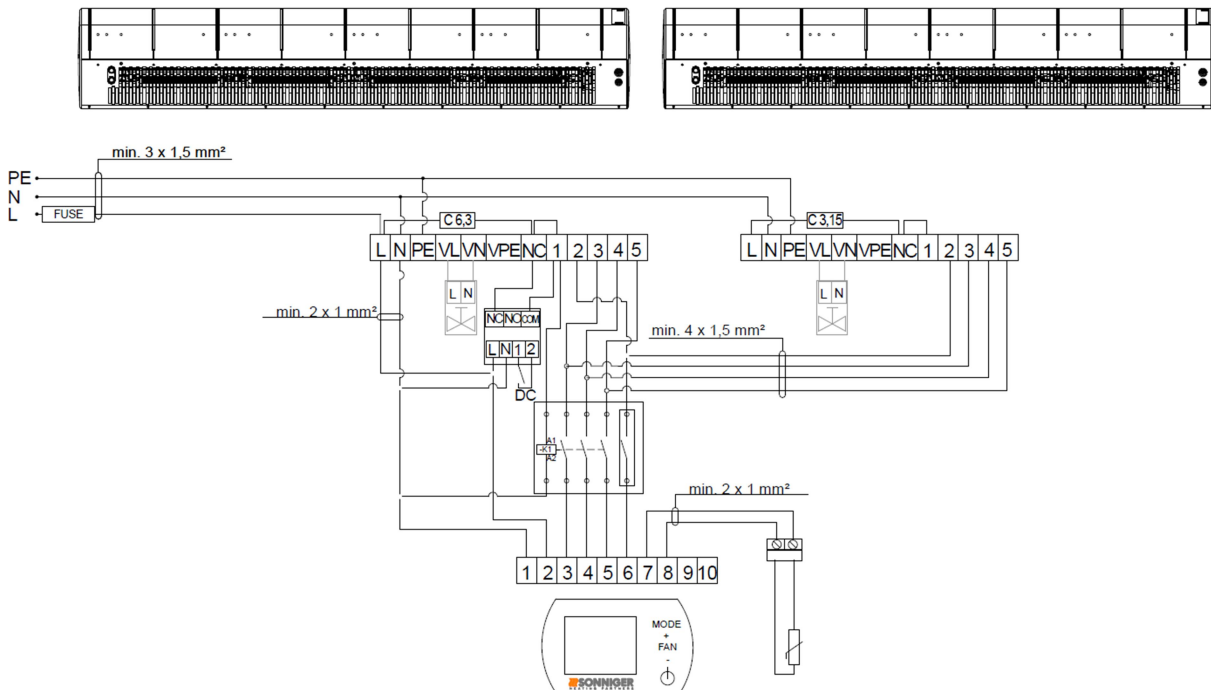

## Operation and Maintenance Documentation GUARD v202301

In the MASTER curtain between the L-NC terminals, replace the factory-made fuse (C 3.15) with C 6.3 (for work with DOOR SWITCH remove the bridge between terminal NC-COM).

### 8.6.2 Without DOOR SWITCH

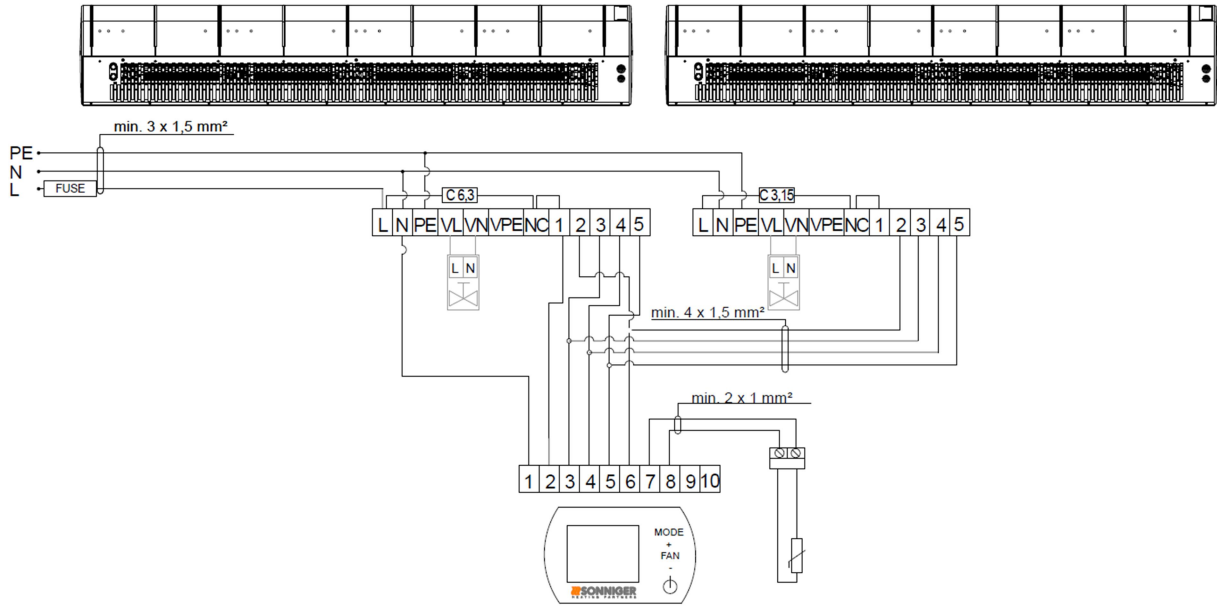

### 8.7 Diagram of connecting one GUARD 100-150-200 E (electric heater) to the INTELLIGENT panel

#### 8.7.1 With DOOR SWITCH

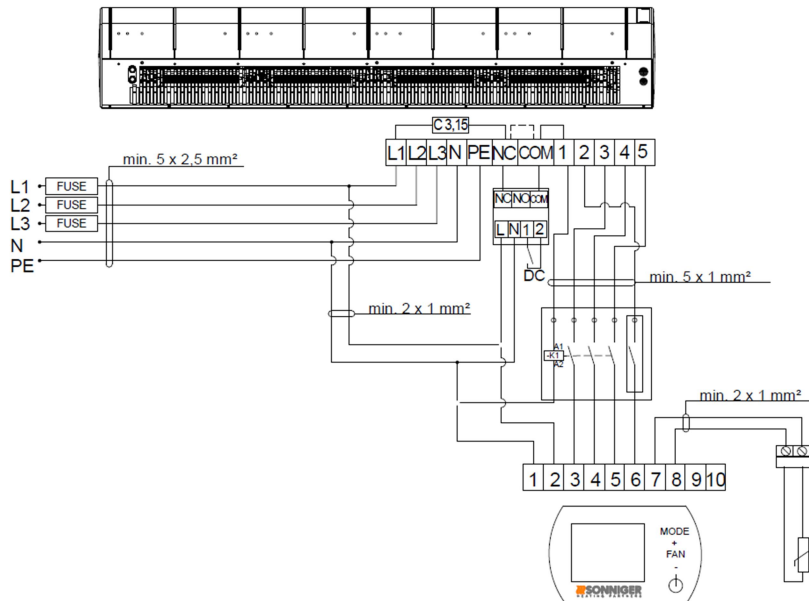

8.7.2 Without DOOR SWITCH

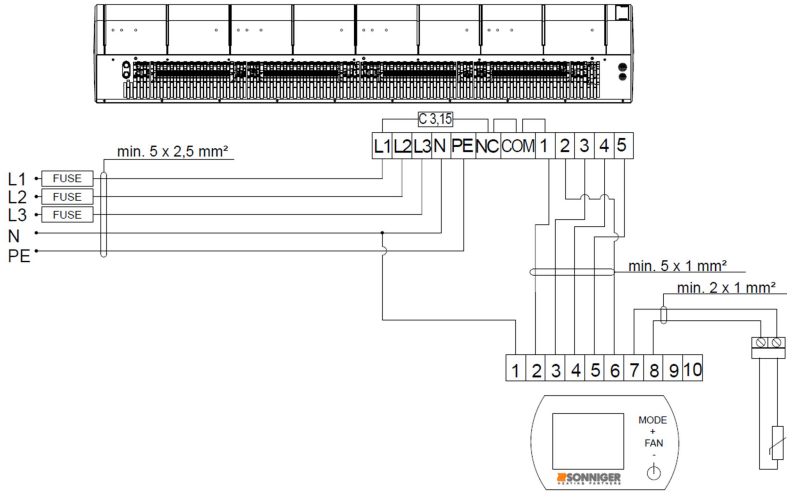

8.8 Diagram of connecting two GUARD 100-150-200 E (electric heater) to the INTELLIGENT panel

8.8.1 With DOOR SWITCH

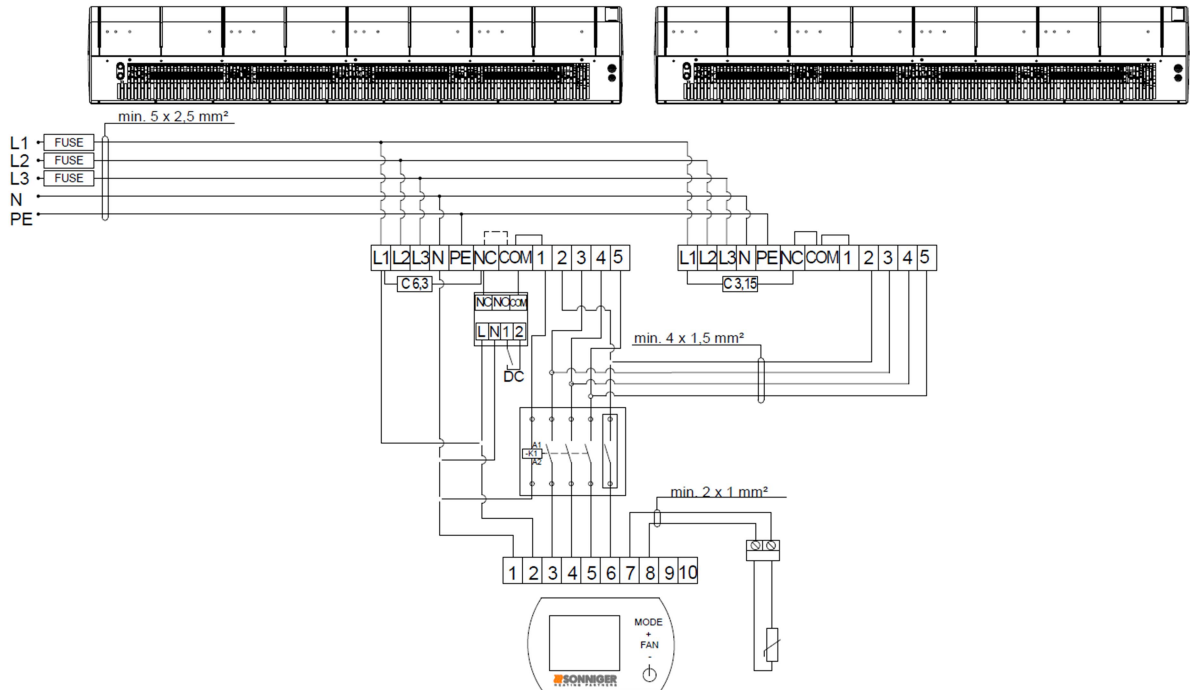

In the MASTER curtain between the L-NC terminals, replace the factory-made fuse (C 3.15) with C 6.3 (for work with DOOR SWITCH remove the bridge between terminal NC-COM).

8.8.2 Without DOOR SWITCH

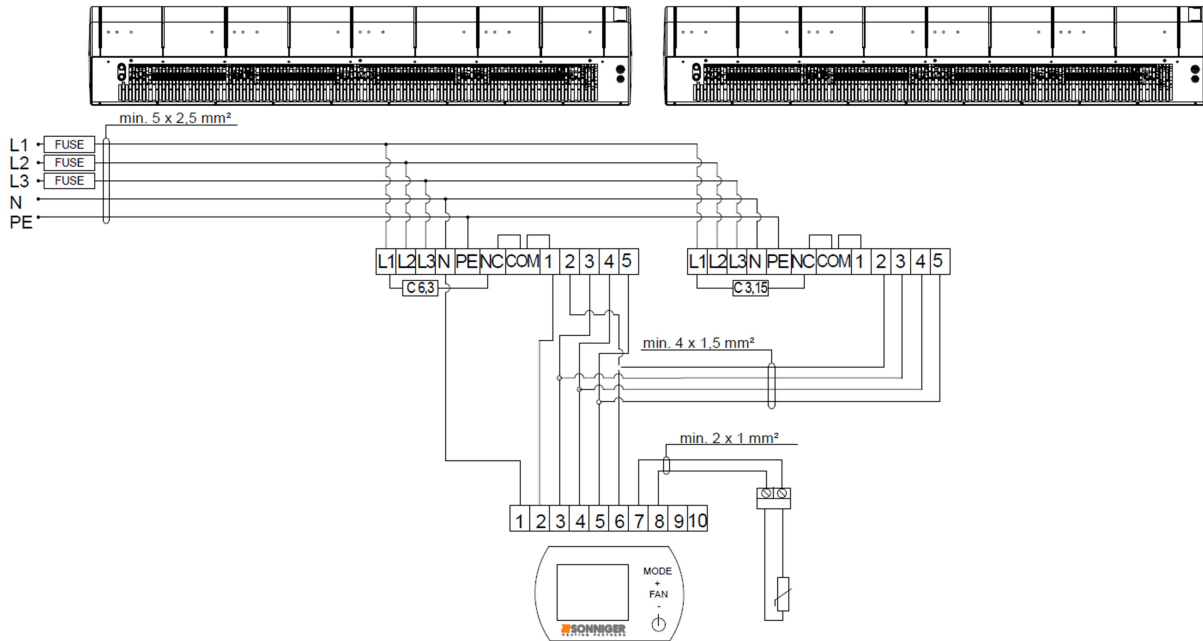

In the MASTER curtain between the L-NC terminals, replace the factory-made fuse (C 3.15) with C 6.3.

**ATTENTION!**

- ① PTC heaters power supply 3x400V/50Hz or 3x400V/60Hz
- ① min. 5 x 2,5 mm for G100E; (B16)
- ① min. 5 x 4 mm for G150E; (B20)
- ① min. 5 x 6 mm for G200E; (B25)

**9. OPERATION AND MAINTENANCE**

The engine and fan of the GUARD air curtains are maintenance-free devices but regular check-ups are advised, especially the motor and bearing (the fan's rotor should rotate freely, free from any axial and radial throws/run-outs and undesired knocks/rattles.

The heat exchanger requires systematic cleaning of all dirt/impurities off. Before the start of the heating period, the heat exchanger is advised to be cleaned with compressed air directed to the air outlets; there is no need for dismantling the device.

Pay special attention when cleaning the exchanger's fin due to the high possibility of damaging them. If the fin is bent use a special tool. If the device has not been used for a longer period, unplug it before the next use.

The heat exchanger is not equipped with any fire protection device. The heat exchanger may be damaged if the room temperature goes below 0°C; anti-freeze liquid must be added to the water circulation/system. Anti-freeze liquid must be appropriate for the material the exchanger is made of (copper) as well as other elements of the hydraulic system/circulation. The liquid must be diluted with water accordingly to the manufacturer's recommendation.

**ATTENTION!**

- ① Any repair and maintenance work must be conducted with the power off and the heat input disconnected.
- ① Only suitably qualified staff well acquainted with the safety regulations concerning handling an electrical device must be employed when the device is being installed, started, and operated
- ① In the event of a coolant leak, when the water system is under pressure, any repairs of the leakage are strictly prohibited.
- ① Any repairs to the device must be conducted only if the device is disconnected from the power supply.
- ① If the device being operated gives a metallic clatter, or vibration or the level of noise is increasing, check if the mounting of the fan has not become loose – in case of any problems contact the installer of the device or the SONNIGER Authorized Service immediately.

## 10 PANEL INTELLIGENT WIFI – programmable controller manual

Panel Intelligent WIFI controls actuators/valves and automatically regulates the fan's speed depending on the required room temperature. The lower temperature in the room the higher the air output is set. Fan speed changes automatically at a lower rate when the temperature in a room gets closer to the desired one. Intelligent WIFI allows to management work of the device via the mobile app TUYA SMART.

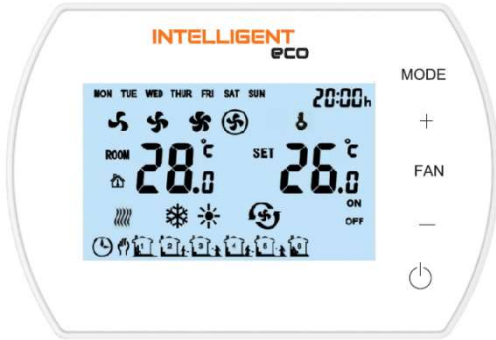

### Functions

- Panel INTELLIGENT is designed for the SONNIGER products
- Weekly thermostat (5/1/1 days)
- Automatic or manual 3-step fan speed adjustment.
- Control room temperature (by opening/closing the valve, or by adjusting air volume automatically).
- Antifreeze mode- protection against dropping room temperature below critical level 5 ~ 15 °C.
- Possibility to connect external NTC temperature sensor.
- BMS communication by MODBUS protocol
- Wireless control via the TUYA SMART app
- Dry contact feedback

### Panel description

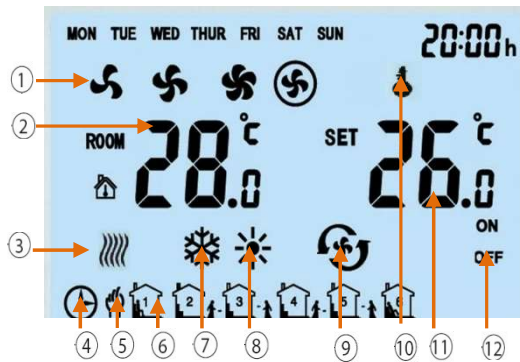

1. Fan Speed: LOW, MED, HI and AUTO
2. ROOM TEMP. or NTC EXTERNAL SENSOR TEMP. (measured temperature)
3. Anti-freeze indication
4. Automatic programable mode
5. Manual mode
6. 6 Time Zones for each day
7. Cooling Mode
8. Heating Mode
9. Ventilation Mode
10. Buttons Lock
11. SET TEMP. (desired room temperature)
12. ON/OFF status of time zones

13. MODE Press shortly to select manual or automatic mode Press and hold for 3 s and select colling, heating or ventilation mode
14. FAN Press shortly and select fan speed: Low, Med, High or Auto
15. ON/OFF INTELLIGENT Panel

### Technical parameters

1	Power supply	230VAC/50Hz
2	Temperature setting range	5°C 40°C
3	Temperature working range	-10°C 60°C
4	IP class	20
5	Temperature sensor	Internal / external NTC (optional)

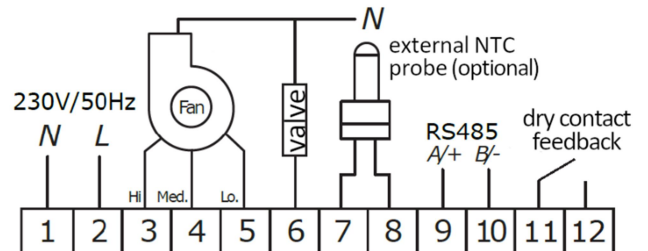

**Dimensions**

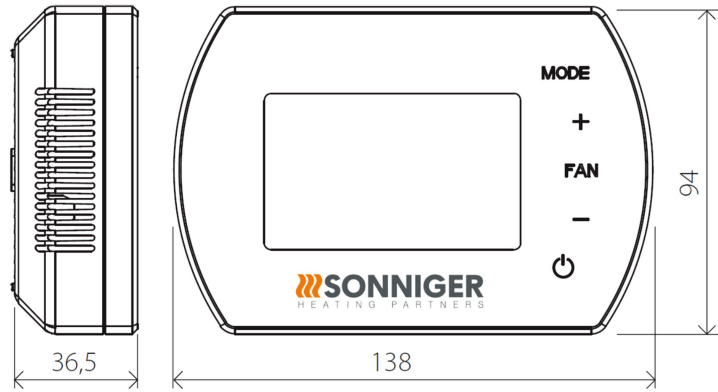

**Settings menu**

When Panel Intelligent is switched off, press and hold MODE for 5 seconds

To change option use MODE button.

To change value use +/- buttons.

Setting menu	Option	Value
1	Temperature calibration	-9°C ~ +9°C
2	EEPROM	0: no memory 1: memory
3	Fan status	C1: Thermostatic mode C2: Continuous mode
4	Temperature sensor	0: Internal Sensor 1: External Sensor NTC (optional)
5	Antifreeze	0: Off 1: On
6	Antifreeze range	+5°C ~ +15°C
7	ALARM	0: disable 1: enable
8	Drycontact	0: NO 1: NC
9	MODBUS	0: disable 1: enable
10	BMS speed	0-2400 / 1-9600 / 2-19200
11	Modbus ID	1~247 (01~F7)

**Button lock / unlock** 

To LOCK buttons press and hold + and then – and hold both of them for 5 seconds.

To UNLOCK buttons press and hold + and then – and hold both of them for 5 seconds.





**Press MODE**

Change on manual mode  or automatic mode 

**Hold MODE for 5 seconds**

Change to cool mode , heating mode , ventilation 







**Press FAN**

Change of the fan speed low , medium , high , automatyczna 

**Hold FAN for 5 seconds**

Manual calendar programming Monday – Friday, Saturday, Sunday 6 settings per day

**BMS Functions**

-  Setting/Reading work parameters
-  Work/Stop conditions
-  Weekly program
-  Temperature
-  Fan speed
-  Heating, ventilation, cool mode
-  Antifreeze mode

No.	Setting	Parameters
1	Working Mode	RS485 Semi-duplex; PC or main controller is master; thermostat is slave
2	Interface	A(+),B(-), 2 wires
3	Baud Rate	0-2400 / 1-9600 / 2-19200
4	Byte	9 bits in total: 8 data bit + 1 stop bit
5	Modbus	RTU Mode
6	Transmission	RTU (Remote Terminal Unit) format (please refer to MODBUS instruction)
7	Thermostat address	1–247 : (0 is broadcast address and stand for all thermostat without response)

**WIFI functions**

- 🔌 Setting/Reading work parameters
- 🔌 Work/Stop conditions
- 🔌 Weekly program
- 🔌 Temperature
- 🔌 Fan speed
- 🔌 Heating, ventilation, cool mode

**CONNECTION INTELLIGENT WIFI WITH TUYA SMAR APP**

1. Download the Tuya Smart app (available at App Store and Google Play)
2. The Control panel connects to the power supply and device, Panel INTELLIGENT should stay off
3. Turn on the Tuya app and follow the instruction in the app
4. For the connection process, please enable the GPS and Bluetooth in the phone
5. To activate the pairing mode in the INTELLIGENT Panel tap twice and hold the "+" symbol for 5 seconds until the "SA" symbol shows on the left side of the screen
6. Choose the „Add device" function, and the app should find the control panel automatically, press the "Add" button, and after completing the configuration process, press "Next" and "Finished"
7. In the absence of the "Add" function, select the "Small devices" tab and the "Thermostat (Wi-Fi)" function. After that enter the data to connect to the selected WiFi network and confirm, and then "Blink slowly".
8. A screen will be displayed with information about searching for a device. After detecting the driver, the connection process is automatic. after completing the configuration process, press "Next" and "Finished"

**SPARE PARTS**

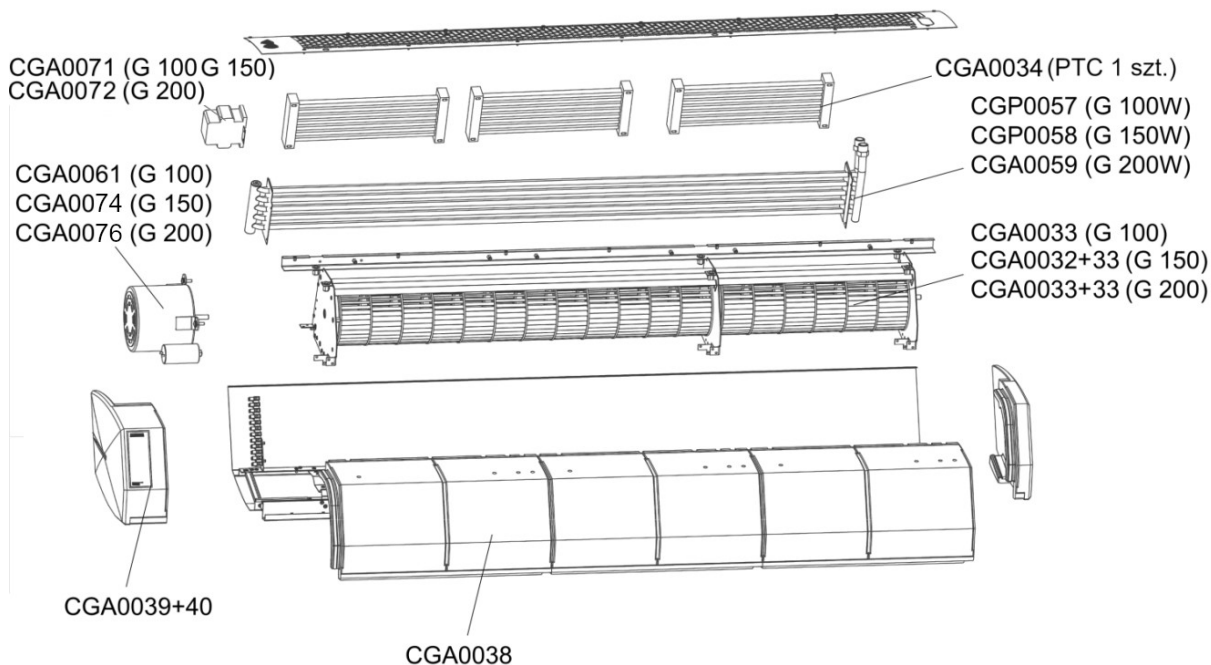

## COMPLIANCE WITH WEEE 2012/19 / EU

In accordance with applicable legal regulations, at the time of purchasing new electrical or electronic equipment with the following mark:



REMEMBER IT IS FORBIDDEN TO PLACE THE WORN EQUIPMENT WITH OTHER WASTE

For information on the waste collection system of electrical and electronic equipment, please contact your distributor

## GUARANTEE TERMS AND CONDITIONS

### § 1 Guarantee Scope

1. This Guarantee covers material defects of the device which make its functioning impossible. This Warranty does not extend to the installation and maintenance works.
2. The Guarantee for the product sold by the Seller covers 24 months. The guarantee period commences upon the delivery of the device to the Buyer specified in the sales invoice. The warranty covers any parts/components specified in the scope of the delivery.
3. Products delivered by third persons are not guaranteed by this supplier.
4. Devices may be started and serviced only by qualified persons trained in the areas of maintenance and operation of the device. Any operations related to starting, maintenance, and repairs must be noted that such operations have occurred in the Guarantee Card.
5. The precondition for issuing the Guarantee by the manufacturer is the assembly and activation of the device following the Operation and Maintenance Documentation not later than 6 months after the date of the purchase.
6. The product is guaranteed for a full period of warranty only if service works implied in the Operation and Maintenance Documentation for the device specified in the 'Maintenance' section are carried out. All services related to the maintenance of the device are carried out at the User's cost and expense.
7. The provision of warranty services does not cease or suspend the duration of the Warranty. The warranty for replaced or repaired parts/elements shall end with the expiry of the Guarantee for the device.

### § 2 Warranty Exclusions/Disclaimers

1. The Warranty does not extend to the mechanical damages and damages to electrical parts caused by improper use, transport, abnormal voltage, or other damages arising from a product defect. For the above reasons, the Warranty is solely limited to the replacement of parts/components having construction defects that shall be delivered without any additional costs only if the defective part/component has been returned.
2. The Warranty for devices does not apply when technical mistakes occurred during the procedures concerning installation, regulation, and control including any of the following:
  - a) Defects caused by connecting a device to an inappropriately designed ventilation system that allows additional heat loads that do not meet any standards and decrease the efficiency of the heat exchanger.
  - b) Defects caused by connecting to the components or parts that are part of the heating system but have not been delivered by the Seller and whose inappropriate functioning harms the device's functioning.
  - c) Defects caused by connecting spare parts to components that are not original parts.
  - d) Defects incurred by reselling the product by the first buyer/user to another buyer who dismantles/installs the device that was previously installed and operated in a specific building and its conditions.
  - e) Defects caused by improper expertise and insufficient knowledge of the installer and technical staff who, improperly carry out after-sale service of the device
  - f) Defects caused by special conditions of use that differ from typical/standard applications unless the parties (the Seller and customer's technical staff) have previously agreed otherwise in writing.
  - g) Defects incurred by natural disasters such as fire, explosions, and other incidents that may result in damages to mechanical, electrical, and protection devices
  - h) Defects are caused by inappropriate cleaning of the technical facility or place where the device has been installed; cleaning must take place periodically to suit the specific working conditions and the amount of dust.
  - i) Defects arised from the absence or improper cleaning of heat exchangers; cleaning must be done periodically to suit the specific working conditions and the amount of dust.
  - j) Defects incurred by the inappropriate installation - inadequate for the low outside temperature of working conditions.
  - k) Defects incurred by the low temperature if no protection device is installed by the installing contractor to avoid:
    - low temperatures on electrical and mechanical parts such as valves, electric and electronic controlling devices,
    - water condensation and frost/ice near the device,
    - thermal shock of the heater and heat exchanger caused by sudden changes of the outside temperature.

### §3. SONNIGER Poland is not liable to:

1. Current maintenance works, and inspections follow from Operation and Maintenance Documentation and device programming.
2. Defects caused by banking of a device while waiting for the warranty service.
3. Any defects caused to the company's property.

#### §4. Complaint Procedure

1. In the event of a complaint under the Warranty conditions, the user may complain directly to the Distributor.
2. All repairs covered by the warranty shall be done as part of the activity of an installation company and Factory Service. All repairs ensuing from the guarantee shall be done in a place where the device is installed.
3. Any services under the Warranty are to be carried out within 14 days from the date of request. In exceptional cases, the deadline may be extended, especially if the warranty service requires ordering parts or components from subcontractors.
4. The user concerning the service activities is obliged to:
  - Allow having full access to the rooms where the devices were installed and provide the necessary facilities allowing direct access to the device (lift, scaffolding, etc.) to do all the servicing covered by the guarantee.
  - Present the original of the Guarantee Card and VAT invoice recording the purchase,
  - Ensure safety while doing the servicing,
  - Allow starting works immediately after the arrival of the Service.
5. In order to make a complaint under the warranty it is necessary to deliver to the Distributor's address the following documents:
  - a) correctly filled-in complaint form that is available at the website of [www.sonniger.com](http://www.sonniger.com)
  - b) copy of the Guarantee Card
  - c) copy of the proof-of-purchase - the sales invoice
6. The repair service including the replacement of the parts shall be done free of charge only if the representative of the installing contractor or the Service claims that the defect or malfunctioning of the device is caused by the fault of the producer.
7. Any costs (cost of repair, travel, and exchanged components) incurred due to the unjustified complaint, especially in the situation when the representative of the Installing Contractor of the Factory Repair Service claims that defect/damage was caused as a result of breaching the guidelines provided in the Operation and Maintenance Documentation or notices the exclusions under §2 (Warranty exclusions) will be requested from the Buyer/Customer who reported the failure.
8. The Claimant is obliged to give a written confirmation of the service provided.
9. Sonniger Poland is entitled to refuse the warranty service if Sonniger Poland has not received full payment for the product complained about under the Guarantee or any previous servicing activities.

## GUARANTEE CARD

**INVESTEMENT:** .....

**Device model:**.....

**Serial number:**.....

**Date of purchase:**.....

**Start date:** .....

**Details of installation company:**

Person activating the device:.....

**Name of company:**.....

.....

Address:.....

Telephone:.....

Signature of a person who has started the device:.....

**Installation works, check-ups/inspections, repairs:**

Date	The scope of installation works, inspections, repairs	Signature and installation company stamp